

Dikkat

- 1- Resim üzerinden ölçü aleti ile ölçü almayın.
- 2- Formu veya ölçüsü değişen resimleri teknik büroya bildirin.
- 3- Resim üzerinde kontrol edenden başkası değişiklik yapamaz.

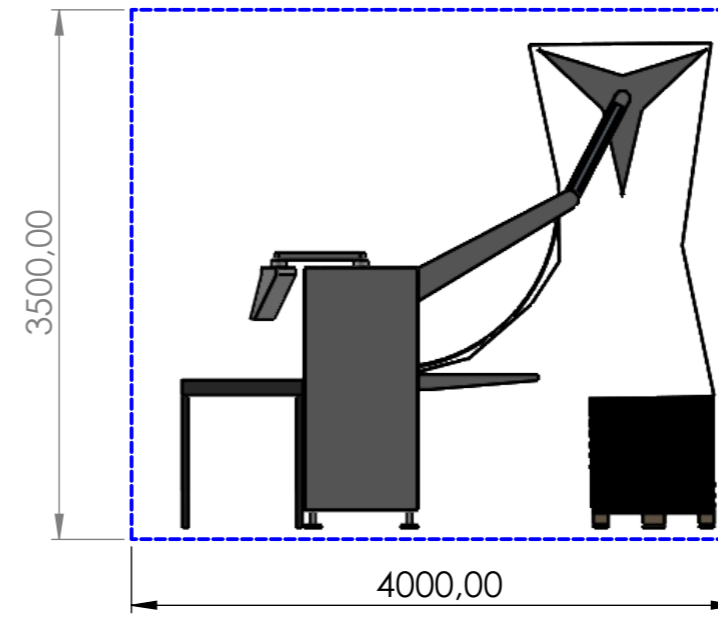
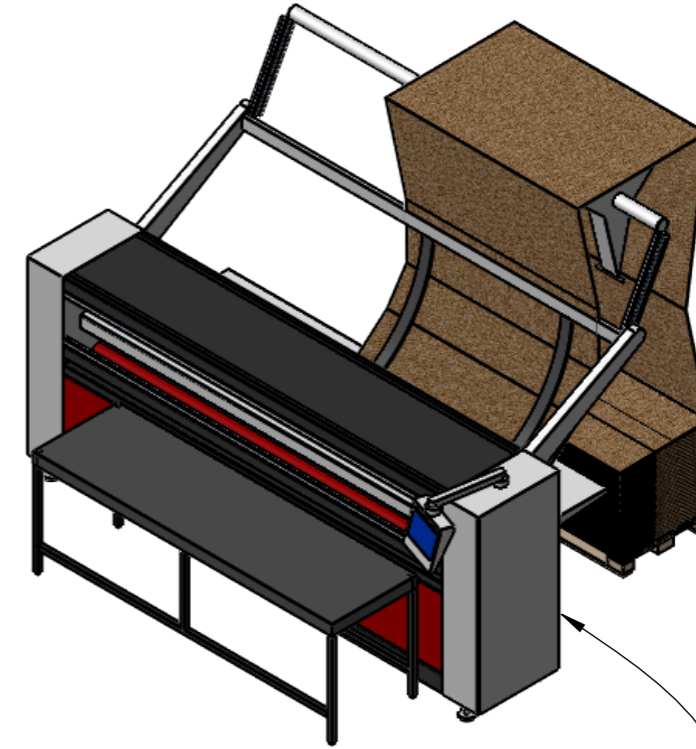
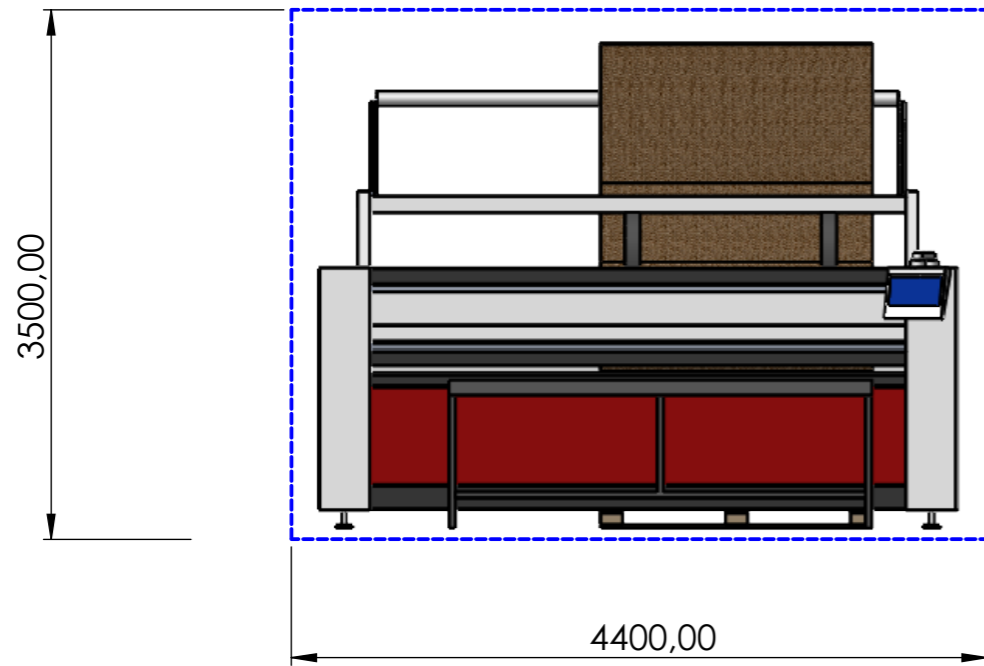
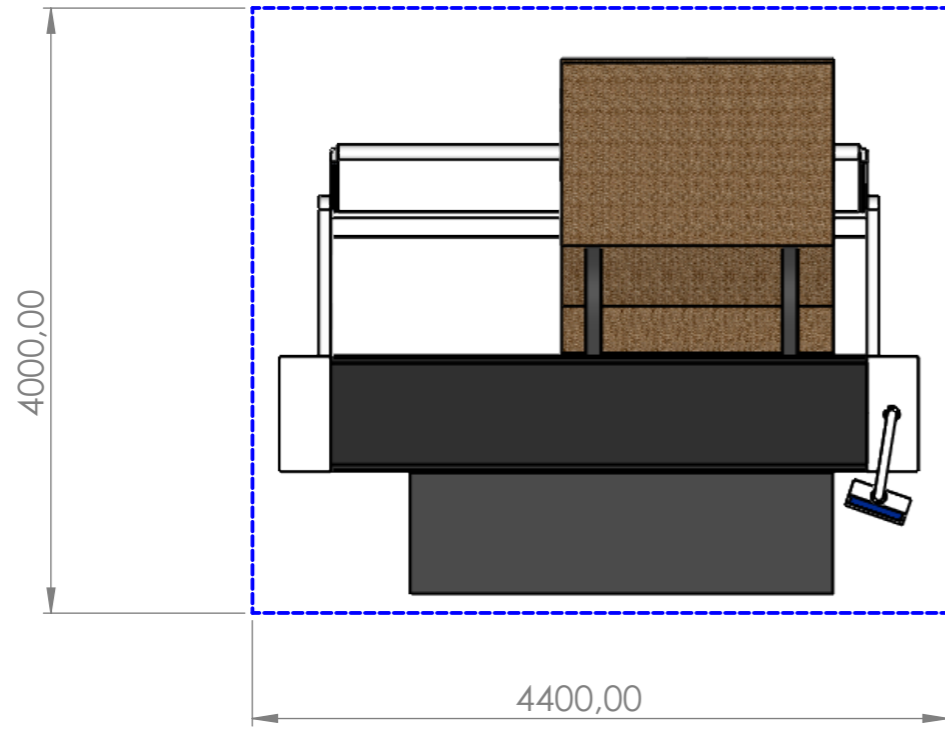

- Total Power: 4,5 KW
- Voltage: 400 V
- Frequency: 50 Hz
- Cable: 5 x 2,5 mm²
- Air Pressure: 6-9 Bar
- Air Flow Rate: 100 L/min
- Air Hose Dia. : Ø8mm

ÖLÇEK SCALE	1:50	SAYFA NO PAGE NR	1/1	MALZEME MATERIAL	AĞIRLIK (Gr) MASS (Gr)	REVİZYON NO REVISION NO	bala [®] VERTICAL PANEL SAW	
ÇİZEN DRAWN BY	ADI - SOYADI NAME - SURNAME		TARİH DATE	PARÇA/MONTAJ ADI PART/ASSEMBLY NAME		AÇIKLAMA DESCRIPTION	ANİTET FORMAT	
ONAY APPROVAL			03.03.2020	404.075 - intelpack 2800-8 layout			A3	